



IXrouter3

Installation Manual

Table of contents

1. Introduction	3
1.1 Technical support	3
2 Product overview	4
2.1 Product family	4
2.2 What's in the box?	4
2.3 Hardware overview.....	5
2.4 Specifications.....	7
2.5 Dimensions.....	9
3. Installation	10
3.1 Considerations.....	10
3.2 Installing and removing from DIN rail	11
3.3 Installing a SIM card.....	11
3.4 Power supply.....	12
3.5 Wiring	12
4. Operation	14
4.1 Configure the IXrouter3	14
4.2 The IXrouter3 local web interface.....	14
4.3 LED status indicators	15
4.4 Reset to factory default.....	16
5. Connectivity requirements (for local IT)	17
5.1 Overview	17
5.2 Servers and DNS requests	17
5.3 MAC or IP address filter	17
6. Compliance	18
6.1 Certifications	18

6.2 Applicable European directives	18
6.3 Applicable safety standards.....	18
6.4 FCC compliance.....	20
6.5 ANATEL.....	21
6.6 NBTC	21

1. Introduction

Thank you for purchasing the IXrouter3. The IXrouter is the standard and most supported hardware for IXON's IXON Cloud. The IXrouter makes it convenient to remotely connect to your equipment, while the built-in firewall keeps your equipment safe from outside threats.

Configuration is as easy as inserting a USB flash drive, which contains your configuration file, into the IXrouter's USB port. The configuration file can be generated from the [Tools] page in the IXON Cloud Fleet Manager app.

1.1 Technical support

If for any reason you need technical assistance, please have a look at our easy-to-read and exhaustive online support articles and guides (support.ixon.cloud), send us an e-mail (support@ixon.cloud), or give us a call at +31 85 744 11 05. Our technical support is available from 8:00 to 17:00 Central European Time, on working days and will answer your questions as soon as possible.

If you have a comment, question, or suggestion about any of our products, services, or manuals, don't hesitate to let us know.

2 Product overview

Seamlessly integrated with the IXON Cloud, the IXrouter is the fastest and safest way to connect your machine to the cloud.

2.1 Product family

The IXrouter3 is available in several variations. No matter your situation, you can always connect your machine to the cloud.

Article no.	Ethernet	4G	Wi-Fi
IX2400	✓		
IX2405	✓	✓	
IX2410	✓		✓
IX2415	✓	✓	✓

Antenna and SIM Card

All models that support 4G and/or WiFi require antennas, which can be purchased separately. SIM Cards for the models that support 4G can be purchased through a telecom provider in your region.

2.2 What's in the box?

The following list describes the contents of the package:

- IXON IXrouter3
- 4GB USB flash drive for configuration
- Female 4-pin plug-in connector with screw connection
(model Weidmuller BL 5.08/04/180 SN BK BX or equivalent)
- Quick Start Guide

2.3 Hardware overview

The IXrouter3 is created with performance and a multitude of hardware capabilities in mind. Figure one, depicted below gives an overview of the hardware functionalities of the IXrouter3.

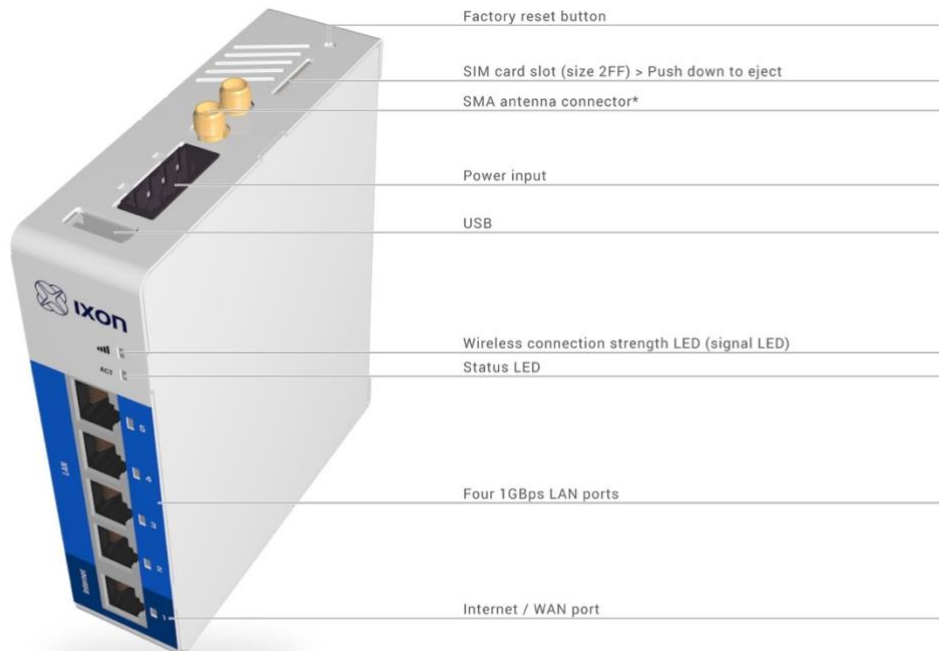

The amount of SMA connectors depends on the model. They are structured according to the following order:

- 4G: The MAIN connector is closest to the power connector, the other connector is DIV. Always connect one antenna to the MAIN connector, the DIV connector is optional.
- 4G & Wi-Fi: The 4G connector is closest to the power connector, the other connector is the Wi-Fi connector.
- Wi-Fi: Only one connector.
- Ethernet: No antenna connectors

Figure 1: Hardware overview



Vierlingsbeekseweg 52A
5825 AX Overloon, NETHERLANDS
Made in The Netherlands

MAC: CO:D3:91:31:BB:CB

WIFI MAC: D4:CA:9E:90:EA:05

IMEI 313513513516435

Input: DC 12-24 V +/- 20%

PW: aBC123def4

FCC ID: XPYLILYW1 IC: 8595A-LILYW1

FCC ID2: XMR201903EG25G IC2: 10224A-201903EG25G

IXrouter 3.0 4G WiFi

IX2415

S/N: 12345678



2052

Figure 2: IXrouter3 label (can be found on the left side of the router)

The label depicted in figure 2 shows some very important information on your specific IXrouter3. On the right side of the label you can find information on certifications, the model and the serial number (s/n). A QR-code with the routers serial number is also provided on the label. On the left side you can find IXON's contact information and the MAC and IMEI numbers, that are unique to your router. A password (PW) to access the local web interface is also in the left side of the label.

2.4 Specifications

The specifications below are applicable for all IXrouter3 variants. The 4G, and Wi-Fi variants each have additional specifications, listed separately.

General specifications	Description
Power supply (recommended)	12-24 VDC +/- 20% LPS 2A
Power consumption	IX2400: 2.5W idle, 10W max Other models: 5W idle, 10W max
Operating temperature	-20°C to 65°C
Relative humidity	10 to 95% non-condensing
Operating altitude	Up to a maximum of 2000m
Storage temperature	-20°C to 65°C
Storage humidity	10 to 95% non-condensing
Storage altitude	Up to a maximum of 3000m
Ethernet ports	4 LAN ports, 1 WAN port. (all 1 Gbps)
USB version	USB 2.0
Processor	MIPS 800 MHz
Digital Input	Yes
Degree of protection	IP20
Mounting	DIN rail
Size	95x116x28mm (excl. DIN rail)
Weight	270-310 gram
Certifications	CE, cULus Listing, FCC Verification, NBTC
Warranty	2 Years

Cellular specifications	Description
Cellular protocols and frequencies	FDD-LTE - B1, B2, B3, B4, B5, B7, B8, B12, B13, B18, B19, B20, B25, B26, B28 TDD-LTE - B38, B39, B40, B41 WCDMA - B1, B2, B4, B5, B6, B8, B19 GSM/GPRS/EDGE - 850, 900, 1800, 1900 MHz
Speed (Max. download/upload)	LTE-FDD - 100Mbps/50Mbps LTE-TDD -.61Mbps/18Mbps

DC-HSPA+ - 42Mbps/5.76Mbps
TD-SCDMA - 4.2Mbps/2.2Mbps
WCDMA - 384Kbps/384Kbps
EDGE - 236.8Kbps/236.8Kbps
GPRS - 85.6Kbps/85.6Kbps

SIM size 2FF (Standard SIM Card)

FCC ID XMR201903EG25G

Wi-Fi specifications

Description

Wi-Fi IEEE 802.11 version

b/g/n

Radio Frequency

2.4 GHz

Wi-Fi modes

Station (Client) Mode and Access Point

Speed

72Mbps

FCC ID

XPYLILYW1

2.5 Dimensions

The IXrouter3 is designed to be easily installed on a standard DIN rail. The small size of the IXrouter3 allows you to make efficient use of space. (Unit of measurement: millimeter.)

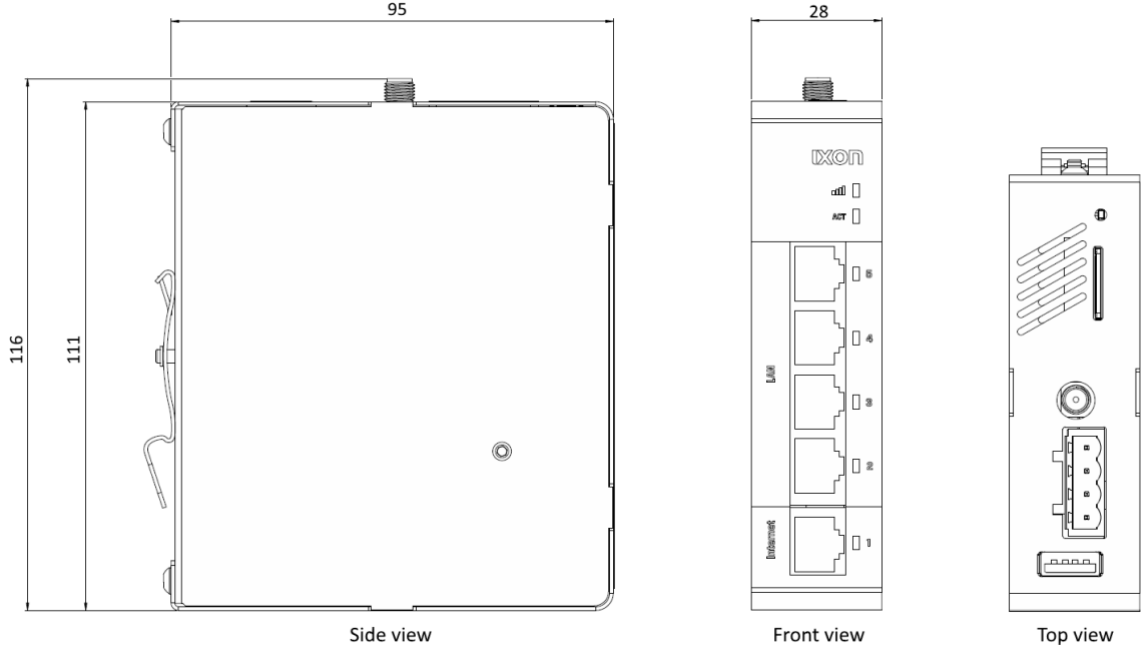

Figure 3: IXrouter3 dimensions

3. Installation

3.1 Considerations

When designing the layout of your system, always separate the devices that generate high voltage and high electrical noise from the low-voltage, logic-type devices such as the IXrouter3.

Also consider the heat-generating devices and locate the electronic-type devices in the cooler areas of your cabinet. Reducing the exposure to a high-temperature environment will extend the operating life of the IXrouter3.

Also consider the routing of the wiring for the devices in the panel. Avoid placing low-voltage signal wires and communications cables in the same tray with AC power wiring and high-energy, rapidly-switched DC wiring.

The IXrouter3 is designed to be cooled using natural convection. For proper cooling, you must provide a clearance of at least 25 mm above and below the device. Also, allow at least 25 mm of depth between the front of the device and the inside of the enclosure.

These devices are open-type and are meant to be installed in an enclosure which is only accessible with the use of a tool. These devices are meant to be suitable for the environment.

Because IXON's IXrouter3 is essentially a small computer, the IXrouter3 can be used for many different purposes. You can, for example, access, program and control industrial machines around the globe. Do not use the IXrouter3 unless you've received proper training or have proper knowledge about the IXrouter3 and its capabilities. It is expected that the user is knowledgeable about networking settings and is aware of the potential consequences for your application.

3.2 Installing and removing from DIN rail

The IXrouter3 can be easily installed on a standard DIN rail. (1) Hang the device on the rail and (2) push the unit down until you feel a click. To remove the unit, (A) pull/rotate the device up and (B) lift off the rail.

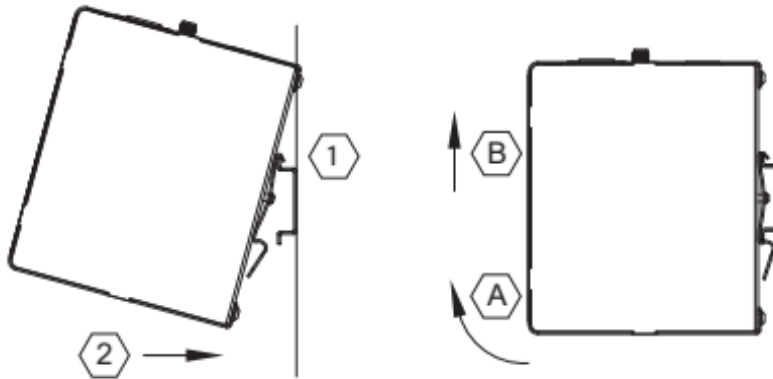

Figure 4: DIN-rail installation

3.3 Installing a SIM card

The SIM card slot suits a Full-Size SIM card (size 2FF).

To insert, push the SIM card into the slot until you feel a click.

This is approximately when the card is fully submerged 1 mm inside the device. Release the card and the card will stay in the device.

The side of the SIM card where you see a golden colored chip should be aligned with the outside of the enclosure as depicted on the router and in the figure on the right.

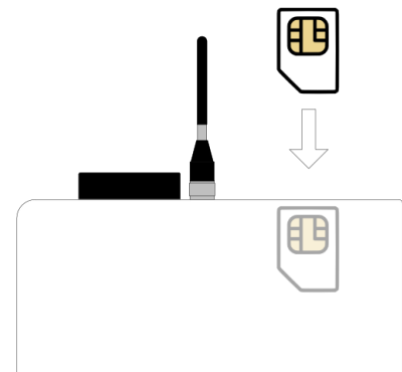

To remove, push the SIM card firmly into the slot until you hear a click. Releasing will cause the SIM card to partially eject, allowing you to easily take out the card.

3.4 Power supply

The IXrouter3 must be powered by an IEC/UL/EN/60950-1 certified Limited Power Supply (LPS) or, for the United States, a Class 2 power supply. The LPS power supply is not included in the package of the IXrouter 3.

Power supply	12-24 VDC +/- 20% LPS 2A
Internal voltage protection	29V max
Input protection	Protected against polarity inversion
Isolation	1.5 kV

3.5 Wiring

Proper grounding and wiring of all electrical equipment are important to help ensure the optimum operation of the IXrouter3 and to provide additional electrical noise protection for your application.

The IXrouter3 comes with a female 4-pin plug-in connector with screw connection (type: Weidmuller BL 5.08/04/180 SN BK BX). The optimal wire diameter is 1.5mm² (16AWG - 12AWG).

Connect the Shield pin of the IXrouter with the protective earth conductor (PE), min. core diameter Cu 1.5 mm².

Wire size range	18 - 12 AWG
Wire strip length	7 mm
Terminal screw torque	0.4 Nm
Max wire length	3m
Min ground conductor	16 AWG

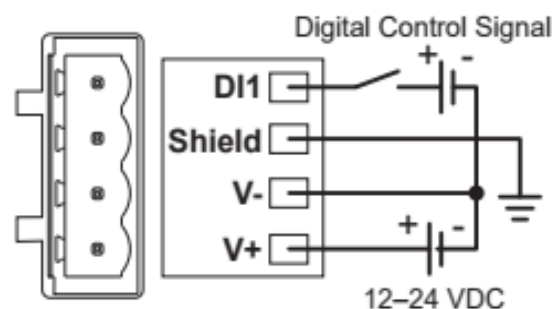

Beware, you have to use the 4-pin plug-in connector included in the IXrouter3 packaging when wiring the IXrouter3. Failing to do so is considered "improper use" Meaning that any damages as a direct result of this are not covered by warranty.

By default, the Digital Input is not configured and doesn't need to be wired. The digital input provides a way to locally manage IXrouter3's VPN connection (ON/OFF). The wiring is depicted in the image above.

Type	optocoupler
Voltage range	0-29 VDC
Voltage range (OFF state)	0-3 VDC
Voltage range (ON state)	7-29 VDC
Current voltage (On state)	2-5 mA

More info

Take a look at our online article for [more detailed information on digital input](#).

4. Operation

4.1 Configure the IXrouter3

To configure your IXrouter3, log in to your IXON Cloud account and navigate to the [Tools] page. Here you can generate an IXrouter configuration file by following a few simple steps. You can then download the configuration file, which must be copied onto a USB flash drive. After supplying power to the IXrouter, insert this USB flash drive in the USB port. The IXrouter3 will register itself to IXON's IXON Cloud and set up a secure VPN connection. You can further configure the IXrouter via the IXON Cloud (portal.ixon.cloud).

More info

For a more extensive manual we recommend viewing our online [step-by-step guides](#).

4.2 The IXrouter3 local web interface

You can use the IXrouter3's local web interface to register the router if it's not registered in the IXON Cloud, change the WAN, LAN and Firewall configurations locally or use the status overview as a more advanced alternative to the LED statuses. You can open the local web interface by connecting your router to your computer using one of the router's LAN ports and entering <http://IXrouter3.lan> in your browser. You have to enter the password on the side of your router to make changes in the local web interface.

More info







For a more extensive explanation on how to use the local web interface, please take a look at our [online article](#).

4.3 LED status indicators









The IXrouter has two LEDs located right above the LAN ports. These show the current status of the IXrouter's connection. The upper LED indicator () displays the signal status, only applicable for 4G/Wi-Fi variants, and the lower LED indicator (**ACT**) shows the activity status.

The table below provides an overview of all possible LED status indications.

Signal LED

	Blinking blue	Initializing cellular module
	Blinking red 1 pulse	No reception or unable to connect to network (APN or SSID may be incorrect)
	Blinking red 2 pulses	PIN invalid or PUK required (a phone is required to unlock SIM card with PUK)
	Blinking red 4 pulses	SIM card is invalid or missing
	Constant red	Connected, poor reception
	Constant purple	Connected, medium reception
	Constant blue	Connected, good reception

ACT Activity LED

	Constant red	Booting up (may take 1-2 min) or not yet registered
	Blinking red 1 pulse	Waiting for internet access
	Blinking red 3 pulses	LAN/WAN conflict (conflicting subnets)
	Blinking red 4 pulses	Removed from the platform (re-insert USB flash drive to register again)
	Blinking red 5 pulses	Previously registered to the IXON Cloud (remove from the IXON Cloud and register again)
	Blinking blue 1 pulse	Connecting to the IXON Cloud
	Blinking blue 2 pulse	Setting up a VPN connection
	Constant blue	Active VPN connection to the IXON Cloud

More info

For a list of most common causes and troubleshooting tips we recommend viewing our online article about [LED Status indicators](#).

4.4 Reset to factory default

After doing a factory reset you'll have to register the device again. If the device is still listed in the IXON Cloud and you want to re-use those settings, make sure to turn on "**Recover upon next registration**" before registering again. The IXrouter3 itself can be reset to the factory default settings by pressing and holding the reset button on top for 5 seconds. The ACT LED will start blinking shortly after the reset button is pressed. Keep holding the button until the LEDs stop flashing and then let go. Wait for the IXrouter3 to restart, this can take up to 2 minutes. You can now reconfigure the IXrouter3 if desired.

Warning!

This cannot be undone. All settings will be reset to factory default.

5. Connectivity requirements (for local IT)

The IXrouter uses outgoing ports to establish a secure connection to our IXON Cloud. This means there is no need to open any incoming ports in your firewall.

5.1 Overview

Below is an overview of the outgoing ports and protocols that the IXrouter utilizes.

Direction	Port	Transport	Application
Outbound	443	TCP	HTTPS, MQTT (TLS) OpenVPN ⁽¹⁾
Outbound	8443 ⁽²⁾	TCP	HTTPS
Outbound	53 ⁽³⁾	TCP & UDP	DNS
Outbound	123 ⁽⁴⁾	UDP	NTP
Outbound	(no port) ⁽⁵⁾	ICMP (Echo request)	-

(1) The very first package may be considered unencrypted as the OpenVPN handshake takes place prior to the TLS handshake. For this reason an exception may be required on firewall rules that block non-SSL traffic over SSL-ports.

(2) Only used when stealth mode is activated for connectivity via a censored internet connection (i.e. when located in China).

(3) DNS requests are often handled by local DNS servers. In those cases the listed DNS port can be ignored.

(4) (Optional) Used to synchronize the time.

(5) Only used when failover is configured.

5.2 Servers and DNS requests

The IXrouter connects to different IXON servers: REST API, MQTT, and OpenVPN servers, which include the following domains: .ixon.cloud; .ixon.net; .ayayot.com (phonetic IIoT).

Doing a DNS lookup (nslookup) at the following domain name always returns an up-to-date IP list of all current IXON servers: whitelist.ixon.cloud

5.3 MAC or IP address filter

Internet access may be granted to specific devices, based on their MAC or IP addresses. The IXrouter's MAC address can be obtained from the label on the side of the IXrouter. The IP address can be set to a static IP address. However, by default the IP address is set to be assigned dynamically via DHCP.

More info

More info detailed information on connectivity requirements is available through our support website.

- How to use [stealth mode](#)
- A guide to [set up a static IP](#)



6. Compliance

6.1 Certifications

The IXrouter3 has been certified for:

- **CE** certification (for more information, see our [Declaration of Conformity](#)).
- **FCC** verification
- **cULus** listing (ID #E492721)
- **ANATEL** (models IX2400 and IX2410)
- **NBTC**
- **Verizon** (4G Global only)



6.2 Applicable European directives

The IXrouter3 is in conformity with the provisions of the following European Directives.

Directive	Description
EMC Directive 2014/30/EU	Product safety
Radio Equipment Directive 2014/53/EU	Use of the radio spectrum
RoHS Directive 2015/863	Restriction of hazardous substances
REACH Directive 1907/2006	Regulation and registration of chemicals
WEEE Directive 2012/19	Waste of electronic equipment

6.3 Applicable safety standards

The IXrouter3 was tested and passed the following standards.

Standard	Description
EN 55032:2012/AC:2013	Electromagnetic Compatibility of Multimedia Equipment
EN 301 489-1 V1.9.2 (2011-09)	EMC Standard for Radio Equipment and Services, Part 1: Common technical requirements

EN 301 489-3 V1.4.1 (2002-08)	EMC Standard for Radio Equipment and Services, Part 3: Specific conditions for Short-Range devices.
EN 61000-6-1:2007	Electromagnetic compatibility (EMC) - Part 6-1: Generic standards - Immunity for residential, commercial and light-industrial environments
EN 61000-6-3:2007/A1:2011/AC:2012	Electromagnetic compatibility (EMC) - Part 6-3: Generic standards - Emission standard for residential, commercial and light-industrial environments
EN 61000-6-2:2005/AC:2005	Electromagnetic compatibility (EMC) - Part 6-2: Generic standards - Immunity for industrial environments
EN 61000-6-4:2007 + A1:2011	Electromagnetic compatibility (EMC) - Part 6-4: Generic standards - Emission standard for industrial environments
EN 61000-4-2:2009	Electrostatic discharge immunity test
EN 61000-4-3:2006 + A1:2008 + A2:2010	Radiated, Radio-frequency, Electromagnetic Field Immunity Test 80-1000 MHz
EN 61000-4-4:2012	Burst Immunity Test
EN 61000-4-5:2014 + A1:2017	Surge Immunity Test
EN 61000-4-6:2014	Immunity to Conducted Disturbances, Induced by Radio-frequency Fields
IEC 60950-1:2006 + A1:2009 + A2:2013	Information Technology Equipment Safety, Part 1: General Requirements - Edition 2
EN 62368-1:2014/AC:2015	Audio/video, information and communication technology equipment - Part 1: Safety requirements
EN 50581:2012	Restriction of the use of certain hazardous substances (RoHS) in electrical and electronic equipment
UL 60950-1	Information Technology Equipment Safety, Part 1: General Requirements - Edition 2
CSA C22.2 No. 60950-1-07 + Amendment 1 and Amendment 2	Information Technology Equipment Safety, Part 1: General Requirements - Edition 2

6.4 FCC compliance

The base equipment (an unintentional radiator) has been tested and complies with the limits for a Class B digital device, pursuant to part 15 of the FCC rules. These limits are designed to provide reasonable protection against harmful interference in a residential installation. This equipment generates, uses, and can radiate radio frequency energy and, if not installed and used in accordance with the manufacturer's instruction manual, may cause interference with radio and television reception.

However, there is no guarantee that interference will not occur in a particular installation. If this equipment does cause harmful interference to radio or TV reception, which can be determined by turning the equipment off and on, the user is encouraged to try to correct the interference by one or more of the following measures:

- Reorient or relocate the receiving antenna.
- Increase the separation between the equipment and the receiver.
- Connect the equipment into an outlet on a circuit different from that to which the receiver is connected.
- Consult the dealer or an experienced radio/TV technician for help.

Notice

Changes or modifications of this equipment not expressly approved by the party responsible for compliance could void the user's authority to operate the equipment.

The IXrouter3 contains different FCC certified modules, depending on the variant.

Article no.	Enclosed module	FCC ID
IX2400	-	-
IX2405	4G	XMR201903EG25G
IX2410	Wi-Fi	XPYLILYW1
IX2415	4G + Wi-Fi	XMR201903EG25G, XPYLILYW1

Additional information for variants with wireless capabilities

This device complies with Part 15 of the FCC Rules. Operation is subject to the following two conditions:

- This device may not cause harmful interference.
- This device must accept any interference received, including interference that may cause undesired operation.

The antenna(s) used with this transmitter must be installed with a separation distance of at least 20cm from all persons and must not be co-located or operated in conjunction with any other antennas or transmitters. Only those antenna(s) tested with the wireless transmitters or similar antenna(s) with equal or lesser gain may be used

6.5 ANATEL

Para maiores informações, consulte o site da ANATEL www.anatel.gov.br.

Este equipamento não tem direito à proteção contra interferência prejudicial e não pode causar interferência em sistemas devidamente autorizados.

6.6 NBTC

เครื่องโทรคมนาคมและอุปกรณ์นี้ ี่ มีความสอดคล้องตามมาตรฐานหรือข้อกำหนดทางเทคนิคของ กสทช.

เครื่องวิทยุคมนาคมนี้ ี่มีระดับการแผ่คลื่นแม่เหล็กไฟฟ้าสอดคล้องตามมาตรฐาน

ความปลอดภัยต่อสุขภาพของมนุษย์จากการใช้เครื่องวิทยุคมนาคมที่คณะกรรมการกิจการโทรคมนาคมแห่งชาติประกาศ หนด.



เครื่องวิทยุคมนาคมนี้ ได้รับยกเว้น ไม่ต้องได้รับใบอนุญาตให้มี ใช้ซึ่งเครื่องวิทยุคมนาคมหรือตั้งสถานีวิทยุคมนาคมตามประกาศ กสทช. เรื่อง เครื่องวิทยุคมนาคม และสถานีวิทยุคมนาคมที่ได้รับยกเว้นไม่ต้องได้รับใบอนุญาตวิทยุคมนาคม ตามพระราชบัญญัติวิทยุคมนาคม พ.ศ. 2498



กสทช. | โทรคมนาคม
กำกับดูแลเพื่อประชาชน
Call Center 1200 (Insw5)

Drawings and official documents

All supporting documents can be found on our support website.

[Click here](#) for more info.